

The Longer You Stay, The Longer You Shop

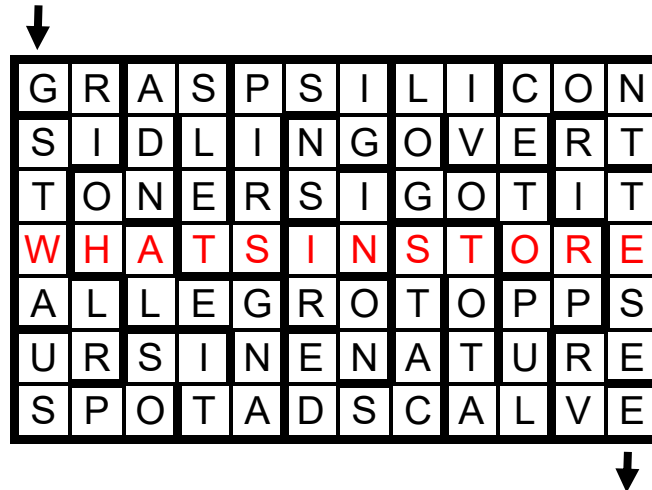

No wonder some of these places are designed like mazes.

Except for row 4, every row in this puzzle contains two answers, the second immediately following the first. The “Path” answers wind their way through the labyrinth, starting at the arrow in the upper-left corner and snaking around until finally exiting in the lower right. Clues for these answers are given in order.



ROWS

- Hold in one’s hands, or understand an idea
___ Valley (high-tech business region near San Francisco)
- Walking like a crab
Blatant; plain as day
- Needs for lasers printers
Outfielder’s shout (3 words)
- Something you might wonder before beginning a shopping spree... or a Puzzled Pint (3 words)**
- Quickly, in music
Big name in baseball cards
- Related to bears
Plants, animals, the seas, etc.
- Commercials intended to be shown at a specific time (2 words)
Have a cow?

PATH

- ___ for the mill
- Large tusked mammal in the Arctic
- Put forward, as an idea
- Actress Bassett of *Black Panther*
- Accords, Civics, Passports, and Pilots
- Goes all-out with one’s effort (2 words)
- Records one’s arrival, say (2 words)
- Got the wrinkles out
- Sings improvisationally in a jazz number
- Add all the charges together (2 words)
- Prefix in front of “-type” or “-plasm”
- Make your website public (2 words)
- Apologetic
- Get a tennis match started

FOREVER 21 page 1

Buying quality clothing shouldn't be a gamble!



Move the cards on the next page (keeping them in the pairs or sets shown) into the three grids seen here to make a total of 21 across every row and down every column. As in blackjack, aces can be worth 1 or 11 points, and the same ace can represent one value across and the other value down. Places do not need to be rotated or reflected. Not every space in a grid will be used.

The unused letters in the three grids spell the answer to this puzzle, COAT LINER.



Where the motto is "Yes, people DO sometimes still read physical books!"

- Two five-letter words in title (PAPER TOWNS)
- Hidden birds (GOLF IN CHINA)
- Author ends in double letters (Benjamin Hoff)

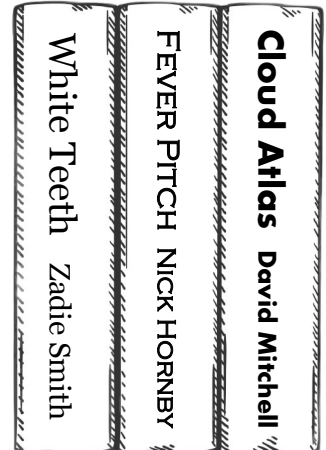
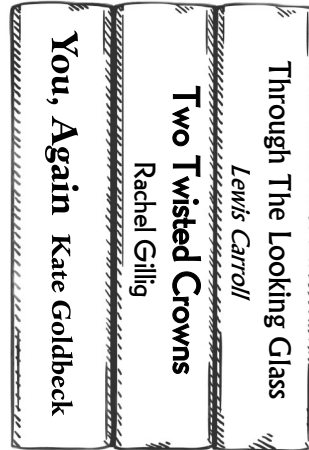
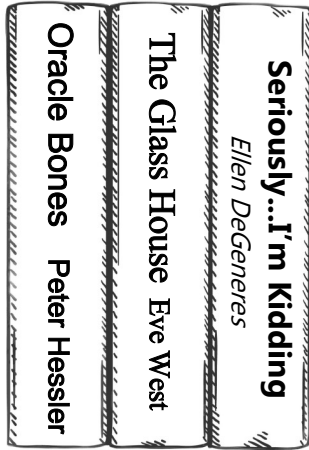

- First words of titles rhyme (WHO MOVED MY CHEESE?)
- Author's last names are synonyms of "brainy" (Margery Sharp)
- Titles include a "deadly sin" (BEDTIME FOR BABY SLOTH)

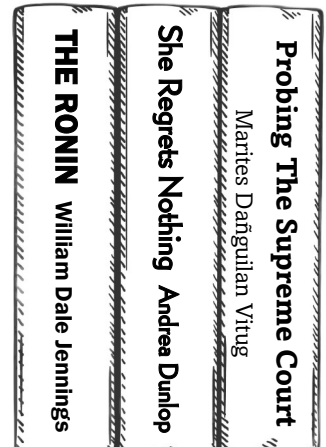
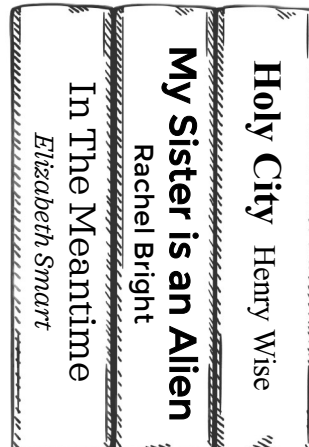
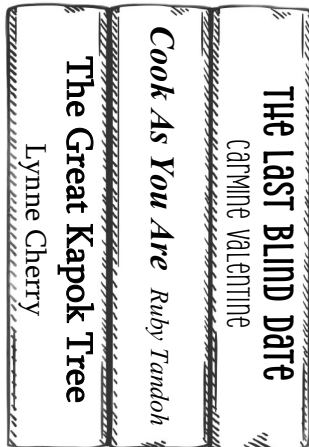

- Author names have only E as a vowel (Helen Lester)
- Author names include shades of red (Rosalind Burgundy)
- First word of title is a musical (COMPANY OF ONE)

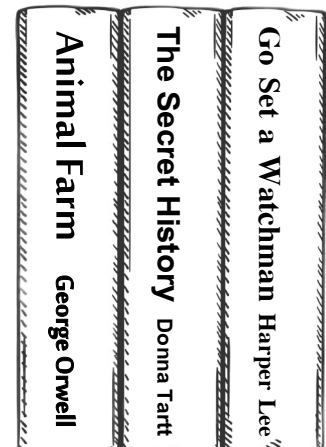
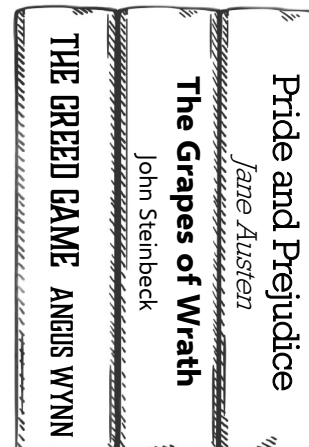
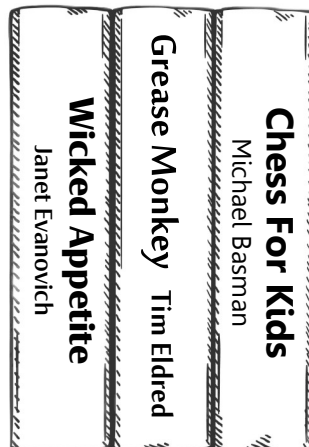

Each pair of numbers specifies one of the three books, and then a letter from that title. (1/4), for example, means to take the fourth letter of the first book. In this manner, spell FRONT PAGE.



A sporting goods store is likely to keep its employees hopping.

Five workers at the sporting goods store (A, B, C, D, and E) are going to compete in a race. Each will sometimes put on a burst of speed, allowing them to skip one of the squares down their column. Skipped spaces can be between answer words or within them. Use Row answers to determine these letters.

Columns

- A** “And the final point I want to make...” • Handheld farming tool with a curved blade • Ending, as of a musical piece • Result of a cannonball into the pool • Do well enough on a test
- B** Prefix meaning “intensely” • Canyon effect • Actress Linney or Dern • *Miss*___ (musical set in Vietnam) • Magical doorway
- C** Emperor killed on the Ides of March • Prefix in front of “space” and “dynamic” • Bit of rice • Wicked old witch, in many a folktale • US state across the Bering Strait from Russia
- D** Slightly off • Give a score from 1 to 10, say • Body part with lashes • ___ out a living (barely gets by) • Ctrl-Z function • Membership costs
- E** Male kids • *La Traviata*, for one • Common piece of bedroom furniture • Packet sold in a nursery • Hidden quantity of goods

Rows

- | | |
|---|---|
| 1 Director George of <i>Star Wars</i> | 15 Actor and playwright Ossie |
| 2 Battle site in San Antonio, Texas | 16 Out of the way, say |
| 3 Oktoberfest vessel | 17 More rational |
| 4 Tie up tightly | 18 Selects |
| 5 Cowboy’s rope | 19 Be of one mind |
| 6 Wish deeply (for) | 20 Like improperly tied shoelaces |
| 7 Toss on the junkpile | 21 Cancel out |
| 8 Angry | 22 Use money |
| 9 Say “Yay team!” | 23 Coin flip option |
| 10 Geographical name following North or South | 24 Some sporty shirts |
| 11 Actor Christopher of <i>Back to the Future</i> | 25 Big pre-season event, in many pro sports |
| 12 More than ready to go | 26 Out on the briny (2 words) |
| 13 Scientist Marie | 27 Japanese alcoholic beverages |
| 14 Exams where you don’t need a pencil | 28 / |

	A	B	C	D	E
1	L	U	C	A	S
2	A	L	A	M	O
3	S	T	E	I	N
4	T	R	U	S	S
5	L	A	S	S	O
6	Y	E	A	R	N
7	S	C	R	A	P
8	I	R	A	T	E
9	C	H	E	E	R
10	K	O	R	E	A
11	L	L	O	Y	D
12	E	A	G	E	R
13	C	U	R	I	E
14	O	R	A	L	S
15	D	A	V	I	S
16	A	S	I	D	E
17	S	A	N	E	R
18	P	I	C	K	S
19	A	G	R	E	E
20	L	O	O	S	E
21	A	N	N	U	L
22	S	P	E	N	D
23	H	E	A	D	S
24	P	O	L	O	S
25	D	R	A	F	T
26	A	T	S	E	A
27	S	A	K	E	S
28	S	L	A	S	H

The skipped letters in the columns give the answer to this puzzle, UNRIVALED.



The lamp department is the place to go for bright ideas in home decorating.

Complete the circuit for each of these nine lamps by placing the word bits into the blanks. Some of the bits are missing a letter, which you will need to fill in. The nine “circuit” words and phrases match the clues shown, but the clues are not given in order.

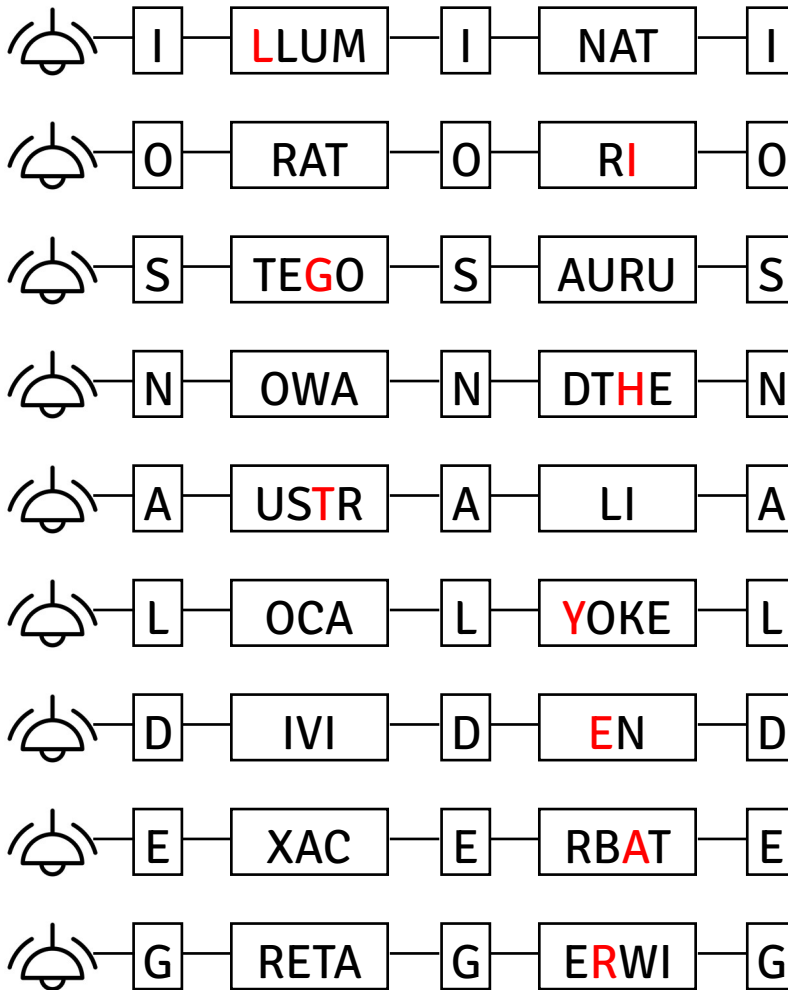

- Bit of income from investments
- Country established on January 1, 1901
- Director of a \$1 billion+ 2023 movie (2 words)
- *Jurassic Park* creature
- Make worse
- Musical work for both orchestra and voices
- Occasionally (3 words)
- Shadowy group
- Small town resident, slangily (2 words)

The letters in the blanks, filled in correctly, spell **LIGHTYEAR**.

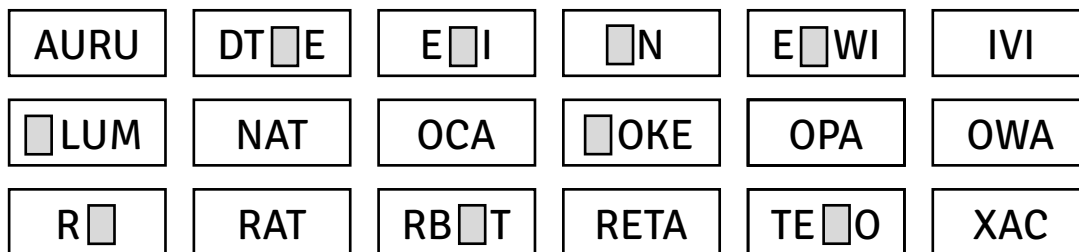

Method of Payment



And then at last the shopping is over and it's time to face the cashier.

If you match your answers to the National Express cards seen here, and then use those previous answers correctly, you will get the answer to the question, **What do you deserve for completing your shopping spree?**

Each of your four nine-letter answers contains within it the first name on one of the cards (LIGHTYEAR, for example, contains TY.) In this way, you can match each answer to a credit card.

NATIONAL EXPRESS

GRPE TANGEO RANGE
8269 574893 27489

RON BERRY
10/8/2024

MISSING LETTERS: A L O
GRAPE TANGELO ORANGE

NATIONAL EXPRESS

IGER GRILLA ERRET
2379 392118 79975

TY WOLF
10/8/2024

MISSING LETTERS: T O F
TIGER GORILLA FERRET

Number the letters in each answer from 1-9, and assign those letters to the numbers on the card.

NATIONAL EXPRESS

ELLO OCAINA CORNT
8552 213673 12974

LIN HORN
10/8/2024

MISSING LETTERS: C R E
CELLO OCARINA CORNET

You will spell out three words that share a category with the cardholder's last name... except that each word is missing a letter.

NATIONAL EXPRESS

INIA RELAND LAVIA
4246 387629 76546

VAL FRANCE
10/8/2024

MISSING LETTERS: D I T
INDIA IRELAND LATVIA

Replacing these letters spells the answer to the puzzle, A LOT OF CREDIT.



Everything in our inventory is now 50% off—not just the price, but the items themselves. Fill in the five letters in each row to figure out what you’re purchasing... and read down one of the columns to find out what else you’re getting.

ACNOP	C	A	N	T	A	L	O	U	P	E	<i>Food and Drink</i>
BEOS	S	N	O	W	B	L	O	W	E	R	<i>Seasonal Goods</i>
CCEKS	C	H	E	E	S	E	C	A	K	E	<i>Food and Drink</i>
EMORT	M	A	R	I	O	N	E	T	T	E	<i>Toys</i>
CELP	E	U	C	A	L	Y	P	T	U	S	<i>Health and Beauty</i>
HNOPU	P	I	N	C	U	S	H	I	O	N	<i>Crafts and Sewing</i>
BLORT	L	O	B	S	T	E	R	P	O	T	<i>Kitchenware</i>
BEOPT	T	A	B	L	E	S	P	O	O	N	<i>Kitchenware</i>
CLNRT	T	U	R	T	L	E	N	E	C	K	<i>Clothing</i>
AAHRY	H	E	A	V	Y	C	R	E	A	M	<i>Food and Drink</i>
AMNSY	M	A	Y	O	N	N	A	I	S	E	<i>Food and Drink</i>
CHLNO	C	E	L	L	O	P	H	A	N	E	<i>Kitchenware</i>
RRSUU	S	A	U	E	R	K	R	A	U	T	<i>Food and Drink</i>
CENNT	C	O	N	C	E	R	T	I	N	A	<i>Musical Instruments</i>
BEEFR	B	I	R	D	F	E	E	D	E	R	<i>Seasonal Goods</i>
CCNPU	C	A	P	P	U	C	C	I	N	O	<i>Food and Drink</i>
BMNWX	M	I	X	I	N	G	B	O	W	L	<i>Kitchenware</i>
ACDEL	C	H	A	N	D	E	L	I	E	R	<i>Lighting Department</i>
BELSS	B	E	S	T	S	E	L	L	E	R	<i>Books</i>