



October 2024 Answer Sheet

Welcome to Puzzled Pint!



Give us
Feedback!

Tonight

- We're here to help! This is not a competitive event. Ask the Game Control volunteers (GC) for hints as often as you'd like. The goal is to have fun, not to be frustrated!

The Puzzles

- Each puzzle will solve to a short word or phrase. How? That's for you to discover.
- Need a code sheet or solving resources? Check out the Resources page on Puzzled Pint's webpage: <http://www.puzzledpint.com/resources/>
- You can use anything to help solve: Use your phone, the internet is fair game! Think your brother might have an insight? Give him a call!
- While each month has a theme, you need no special knowledge of the theme to solve.

About Puzzled Pint

- How did tonight go? Fill out the survey with the QR code above.
- We're an all-volunteer organization.
 - Help us run locally: Talk with Game Control about how you can volunteer.
 - Help us run globally: <https://www.patreon.com/PuzzledPint>

We are always looking for puzzle sets for future months! Check out how you can could write puzzle for Puzzled Pint by going here: <http://www.puzzledpint.com/info/author/>

Team Name:

Start Time:

Team Size:

End Time:



Puzzle Answers	
Forever 21	
Barnes and Noble	
Dick's Sporting Goods	
Ikea	
Meta: Method of Payment	
Bonus: 50% Off (optional)	

FOREVER 21 page 1

Buying quality clothing shouldn't be a gamble!



Move the cards on the next page (keeping them in the pairs or sets shown) into the three grids seen here to make a total of 21 across every row and down every column. As in blackjack, aces can be worth 1 or 11 points, and the same ace can represent one value across and the other value down. Places do not need to be rotated or reflected. Not every space in a grid will be used.

U	N	C	
N	N		D
O	I	T	I
	N	A	L

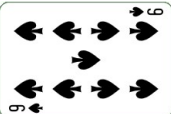
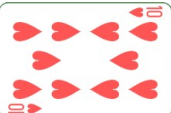
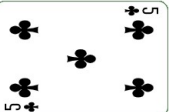
	S	A	T
E	L	L	
I	T	E	D
I	S		H

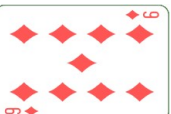
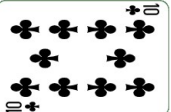
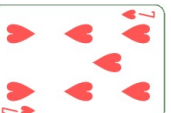
L	I	C	E
		N	S
E	N	U	M
B	E	R	

Where the motto is "Yes, people DO sometimes still read physical books!"

BARNES & NOBLE page 1

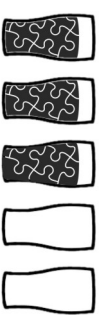

The store's new employee has an unusual way of sorting books into categories. Can you figure out what each set of three books has in common, and add one more book from the pool on the next page? The commonality might be found in the titles, or in author's names.

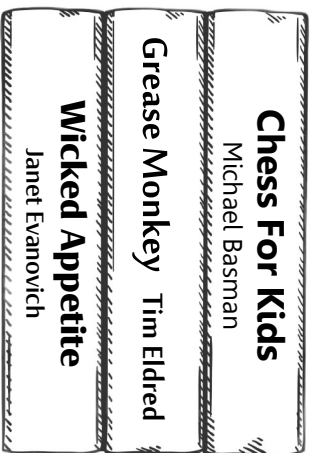
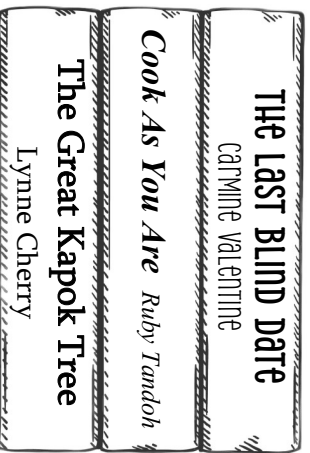
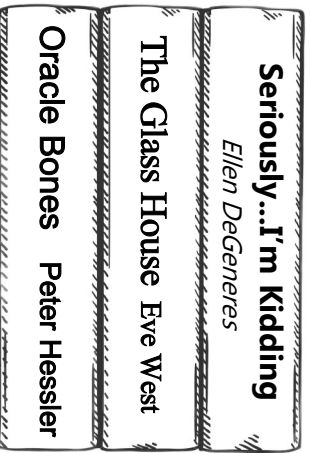
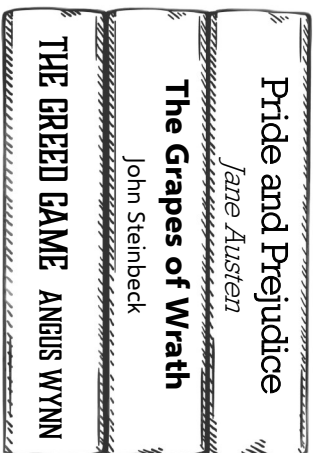
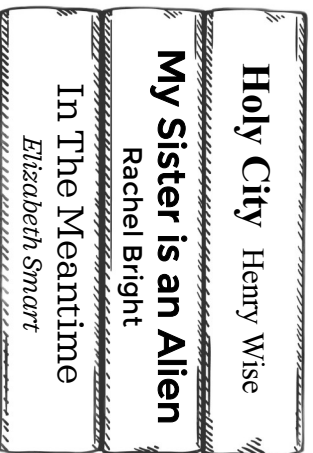
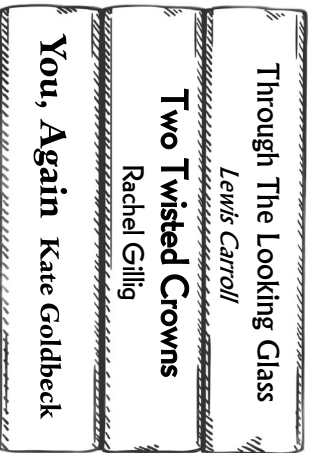
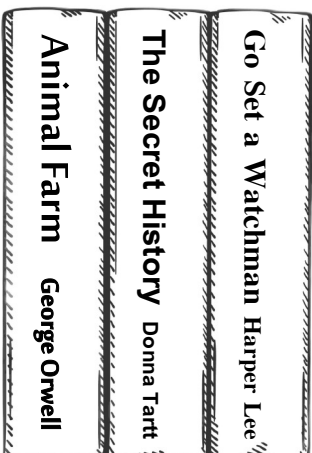
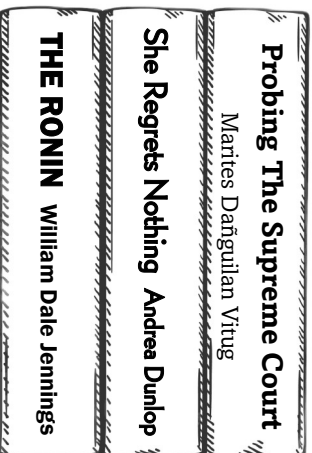
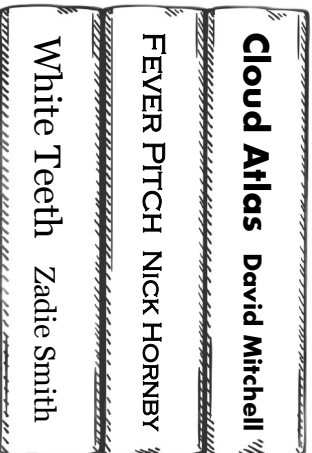



**Clues to the categories
 (not presented in order):**

- Did you know that birds are experts at camouflage?
- Eeeeeee!
- Everything's five by five!
- Hey, you're pretty brainy!
- I know this answer and it makes me want to *sing*!
- In the end, I'm seeing double.
- It's a sin if you don't get this one.
- Ooh, ooh, I know this one!
- This one has me seeing red.

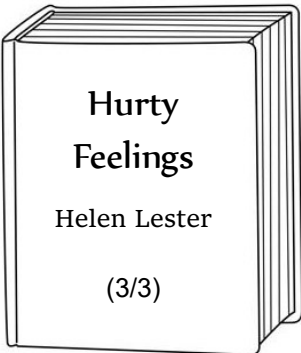
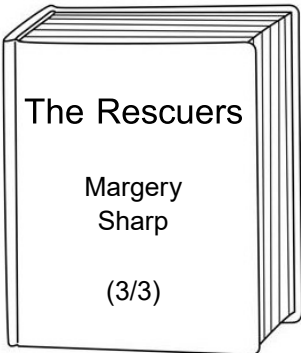
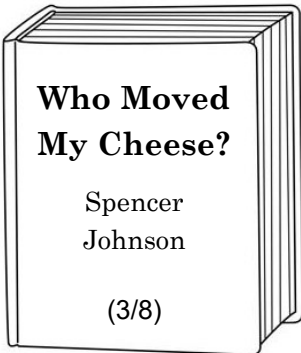
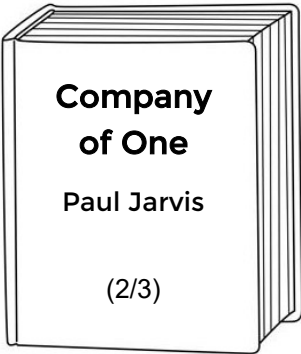
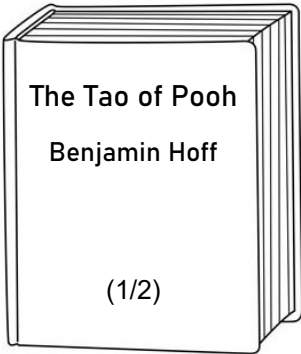
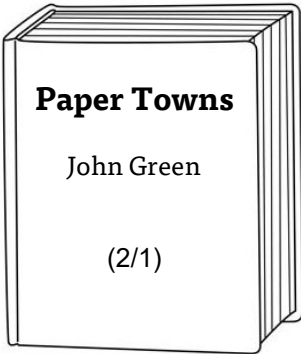
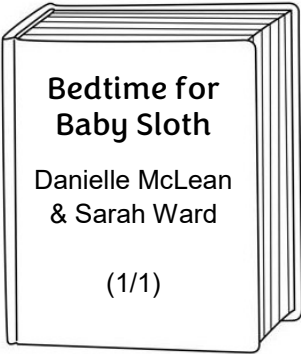
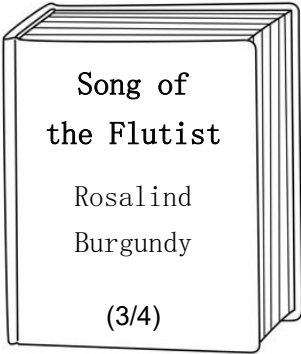
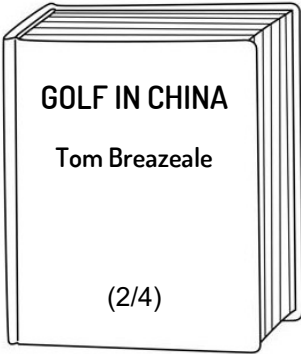



A sporting goods store is likely to keep its employees hopping.

Five workers at the sporting goods store (A, B, C, D, and E) are going to compete in a race. Each will sometimes put on a burst of speed, allowing them to skip one of the squares down their column. Skipped spaces can be between answer words or within them. Use Row answers to determine these letters.

Columns

- A** “And the final point I want to make...” • Handheld farming tool with a curved blade • Ending, as of a musical piece • Result of a cannonball into the pool • Do well enough on a test
- B** Prefix meaning “intensely” • Canyon effect • Actress Linney or Dern • *Miss*___ (musical set in Vietnam) • Magical doorway
- C** Emperor killed on the Ides of March • Prefix in front of “space” and “dynamic” • Bit of rice • Wicked old witch, in many a folktale • US state across the Bering Strait from Russia
- D** Slightly off • Give a score from 1 to 10, say • Body part with lashes • ___ out a living (barely gets by) • Ctrl-Z function • Membership costs
- E** Male kids • *La Traviata*, for one • Common piece of bedroom furniture • Packet sold in a nursery • Hidden quantity of goods

Rows

- | | |
|---|---|
| 1 Director George of <i>Star Wars</i> | 15 Actor and playwright Ossie |
| 2 Battle site in San Antonio, Texas | 16 Out of the way, say |
| 3 Oktoberfest vessel | 17 More rational |
| 4 Tie up tightly | 18 Selects |
| 5 Cowboy’s rope | 19 Be of one mind |
| 6 Wish deeply (for) | 20 Like improperly tied shoelaces |
| 7 Toss on the junkpile | 21 Cancel out |
| 8 Angry | 22 Use money |
| 9 Say “Yay team!” | 23 Coin flip option |
| 10 Geographical name following North or South | 24 Some sporty shirts |
| 11 Actor Christopher of <i>Back to the Future</i> | 25 Big pre-season event, in many pro sports |
| 12 More than ready to go | 26 Out on the briny (2 words) |
| 13 Scientist Marie | 27 Japanese alcoholic beverages |
| 14 Exams where you don’t need a pencil | 28 / |

	A	B	C	D	E
1					
2					
3					
4					
5					
6					
7					
8					
9					
10					
11					
12					
13					
14					
15					
16					
17					
18					
19					
20					
21					
22					
23					
24					
25					
26					
27					
28					



The lamp department is the place to go for bright ideas in home decorating.

Complete the circuit for each of these nine lamps by placing the word bits into the blanks. Some of the bits are missing a letter, which you will need to fill in. The nine “circuit” words and phrases match the clues shown, but the clues are not given in order.

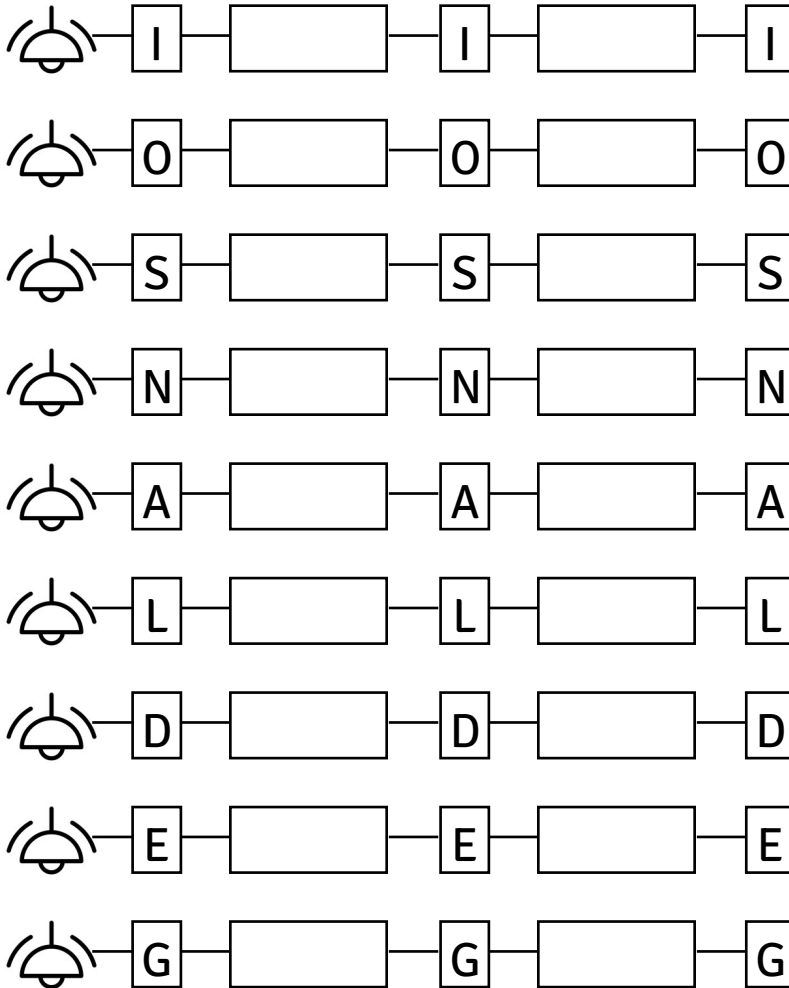

- Bit of income from investments
- Country established on January 1, 1901
- Director of a \$1 billion+ 2023 movie (2 words)
- *Jurassic Park* creature
- Make worse
- Musical work for both orchestra and voices
- Occasionally (3 words)
- Shadowy group
- Small town resident, slangily (2 words)

AURU	DT□E	E□WI	IVI	LI	□LUM
□IN	NAT	OCA	□OKE	OWA	R□
RAT	RB□T	RETA	TE□O	US□R	XAC

Method of Payment



And then at last the shopping is over and it's time to face the cashier.

Something hiding in your four answers will allow you to match those answers to the National Express cards seen here. If you then use those answers correctly, you will get the answer to the question, **What do you deserve for completing your shopping spree?**

NATIONAL EXPRESS

8269 574893 27489

RON BERRY
10/8/2024

NATIONAL EXPRESS

2379 392118 79975

TY WOLF
10/8/2024

NATIONAL EXPRESS

8552 213673 12974

LIN HORN
10/8/2024

NATIONAL EXPRESS

4246 387629 76546

VAL FRANCE
10/8/2024

*If you enjoyed this set of puzzles, check out
puzzlemaker Eric Berlin's work at...*



<http://www.puzzlesnacks.com>

*Download-and-print puzzle packs
Mini puzzle hunts
Puzzles for kids*



Everything is on sale in this bonus puzzle.

Everything in our inventory is now 50% off—not just the price, but the items themselves. Fill in the five letters in each row to figure out what you’re purchasing... and read down one of the columns to find out what else you’re getting. Categories for each answer are given.

ACNOP	A	T	L	U	E	<i>Food and Drink</i>
BE OOS	N	W	L	W	R	<i>Seasonal Goods</i>
CCEKS	H	E	E	A	E	<i>Food and Drink</i>
EMORT	A	I	N	T	E	<i>Toys</i>
CELPU	U	A	Y	T	S	<i>Health and Beauty</i>
HNOPU	I	C	S	I	N	<i>Crafts and Sewing</i>
BLORT	O	S	E	P	T	<i>Kitchenware</i>
BE OPT	A	L	S	O	N	<i>Kitchenware</i>
CLNRT	U	T	E	E	K	<i>Clothing</i>
AAHRY	E	V	C	E	M	<i>Food and Drink</i>
AMNSY	A	O	N	I	E	<i>Food and Drink</i>
CHLNO	E	L	P	A	E	<i>Kitchenware</i>
RRSUU	A	E	K	A	T	<i>Food and Drink</i>
CENNT	O	C	R	I	A	<i>Musical Instruments</i>
BEEFR	I	D	E	D	R	<i>Seasonal Goods</i>
CCNPU	A	P	C	I	O	<i>Food and Drink</i>
BMNW X	I	I	G	O	L	<i>Kitchenware</i>
ACDEL	H	N	E	I	R	<i>Lighting Department</i>
BELSS	E	T	E	L	R	<i>Books</i>