



November 2024 Classic Games Answer Sheet



Give us
Feedback!

Welcome to Puzzled Pint!

Tonight

- We're here to help! This is not a competitive event. Ask the Game Control volunteers (GC) for hints as often as you'd like. The goal is to have fun, not to be frustrated!
- You can find complete information about this puzzle set online at: <http://puzzledpint.com>
 - Go to the location page there to find out if your location is running virtually and how to contact your local GC.
 - Look there for online remote solving tools for remote teams, like google-sheets and answer checkers.
- How did tonight go? Email us at Feedback@puzzledpint.com or fill out a brief survey at the QR code link above.

The Puzzles

- Each puzzle's solution will be a short word or phrase. How do you find it? That's for you to discover!
- Need a code sheet or solving resources? Check out the Resources page on Puzzled Pint's webpage: <http://www.puzzledpint.com/resources/>
- You can use anything to help solve: Use your phone; the internet is fair game! Think your brother might have an insight? Give him a call!
- While each month has a theme, you need no special knowledge of the theme to solve.

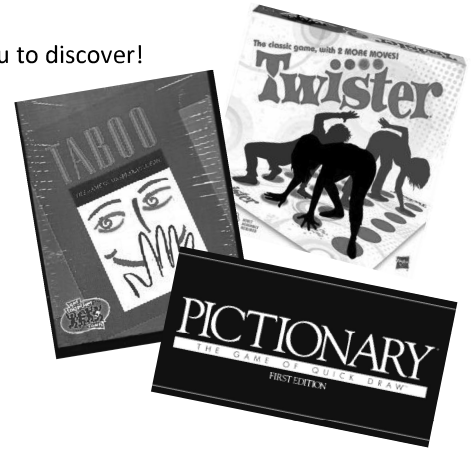

About Puzzled Pint

- We're an all-volunteer organization.
- Help us run locally: Talk with Game Control about how you can volunteer.
- Help us run globally: <https://www.patreon.com/PuzzledPint>

Team Name: _____

Start Time: _____

Team Size: _____

End Time: _____

| Puzzle Answers | |
|------------------|--|
| Apples to Apples | |
| Pictionary | |
| Twister | |
| Taboo | |
| Meta: Clue | |
| Bonus: Simon | |

Apples to Apples



In Apples to Apples, you pick the red apple card that's most like the green apple. In the "Sour Apples to Apples" variant below, search in the tree and pick the red apples that are the most unlike the green apples. It's easiest to compare apples to apples when you look **underneath the skin**. That **leaves** no question about what's at the core of the game.

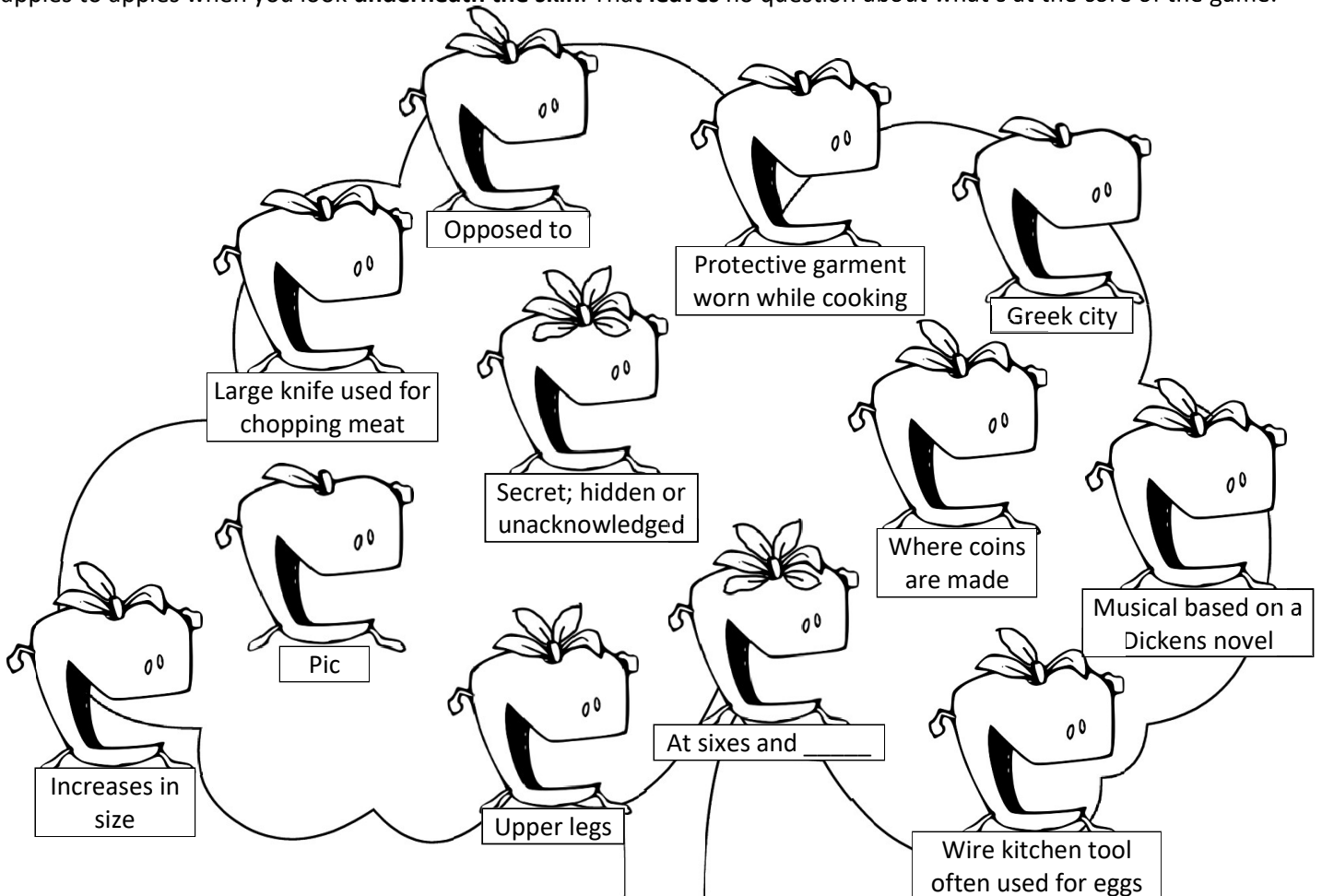

| GREEN APPLE | SOUR MATCH |
|-------------|------------|
| ADIEU | _____ |
| FUNDERS | _____ |
| TODDY | _____ |
| CLOSEST | _____ |
| SCONE | _____ |
| SCOLDS | _____ |

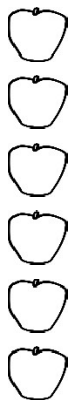

| GREEN APPLE | SOUR MATCH |
|-------------|------------|
| VILLA | _____ |
| SNOWY | _____ |
| CENTERS | _____ |
| THERE | _____ |
| YOUTH | _____ |
| CLOWN | _____ |

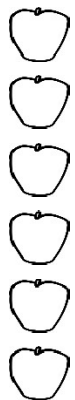

Why does the group like to play Apples to Apples?

Pictionary



Team A

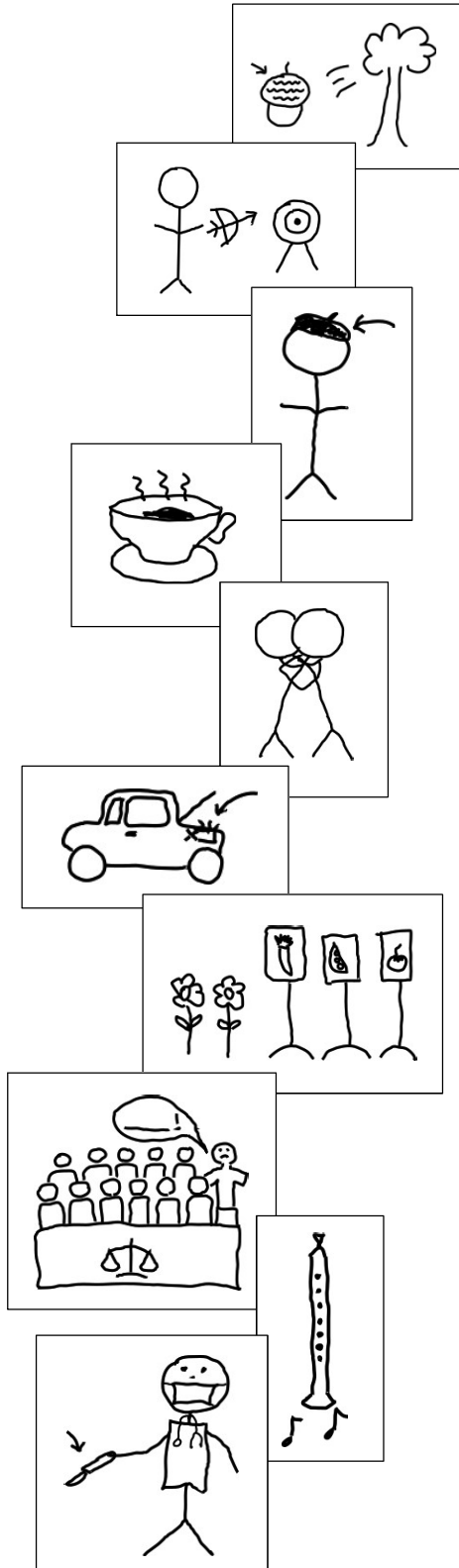

Team B

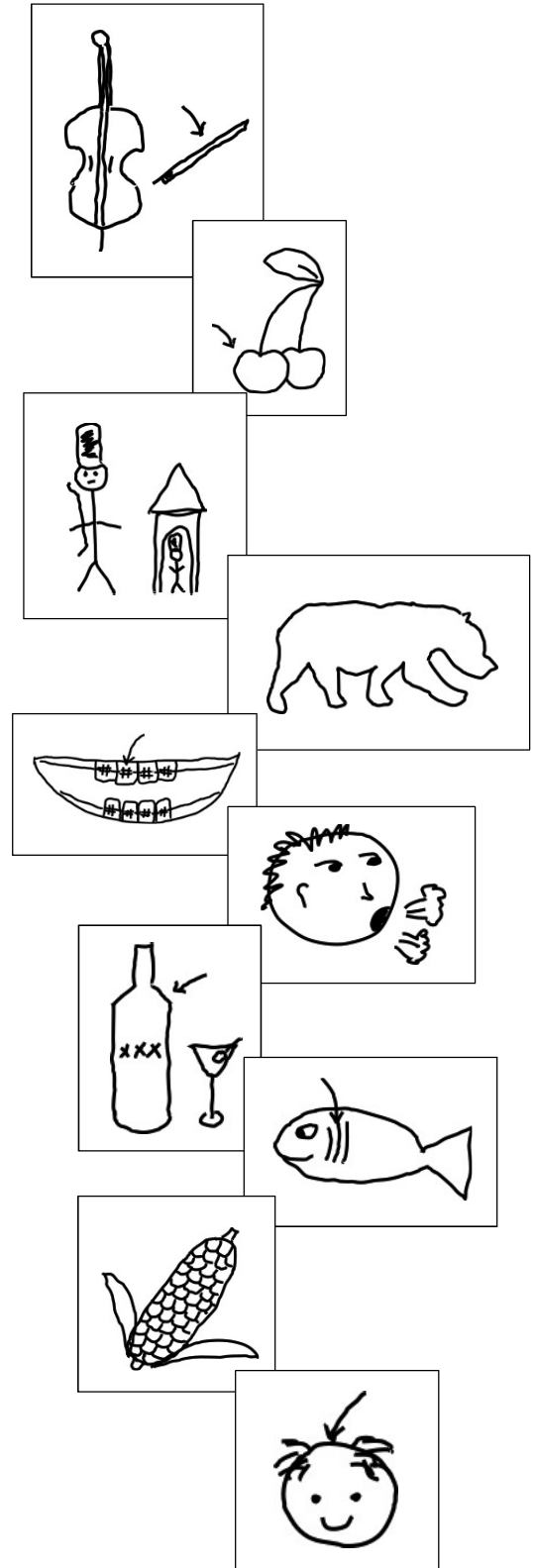

These two teams are trying to draw the same ten words, but Team B did theirs in a different order and they kept missing something!

Twister (1/2)



Ava and Bailey decided to play a game of Twister using only the first, second, and third rows of spots on the mat. They alternate whose turn it is each step of the way.



- A** 1. Ava spun the spinner. Left hand on green. "I'll use the second spot. This game is easy!"
- B** 2. Bailey's turn. "Oh nice, I'm using the same hand as Ava, also on the second spot, just in a different color."
- A** 3. "Same hand, horizontally next to where Bailey ended up. Too bad I had to move my hand to a different spot."
- B** 4. "This time it's my foot, the same side of my body as my hand that's already down, and the same color. I'll use the third spot."
- A** 5. Ava's turn. Left foot on yellow. "Oh good, no one is on this color yet! I'll use the first spot."
- B** 6. Bailey spun the spinner. "This time it's the hand I haven't used yet. It's going two spots away horizontally from Ava's last turn, in the spot next to my other hand."
- A** 7. "Oh, this is a stretch! I have to use the first green spot for something on my right side."
- B** 8. "OK, I have to move the foot that I already placed. I can't reach anything else so I'll just use the first green spot. Maybe Ava won't notice even though her foot is already there..."
- A** 9. "Hey, that's cheating! I'll just move my left hand to where my left foot already is."

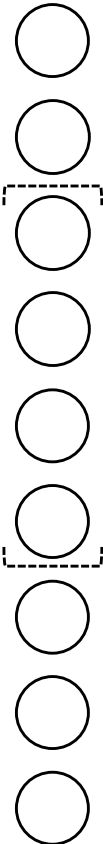

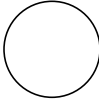
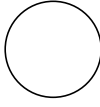
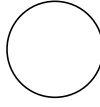
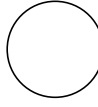
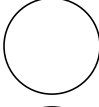
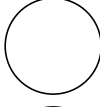
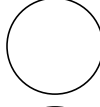
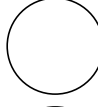
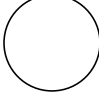
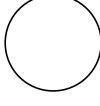
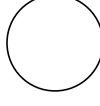
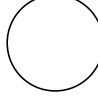
| | G | Y | B | R | |
|--|---|---|---|---|-------------|
| |  |  |  |  | First spot |
| |  |  |  |  | Second spot |
| |  |  |  |  | Third spot |

Use this workspace to keep track of the Twister moves.



Twister (2/2)

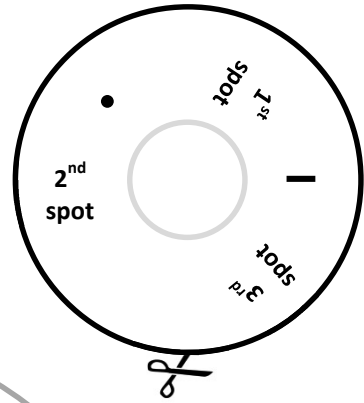
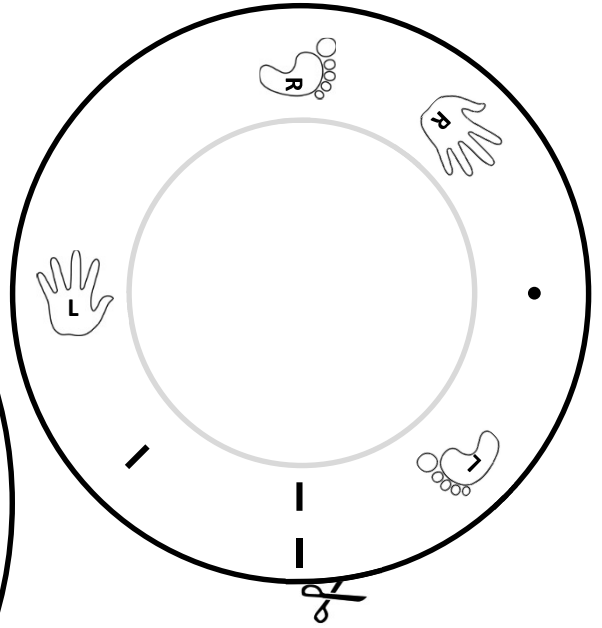
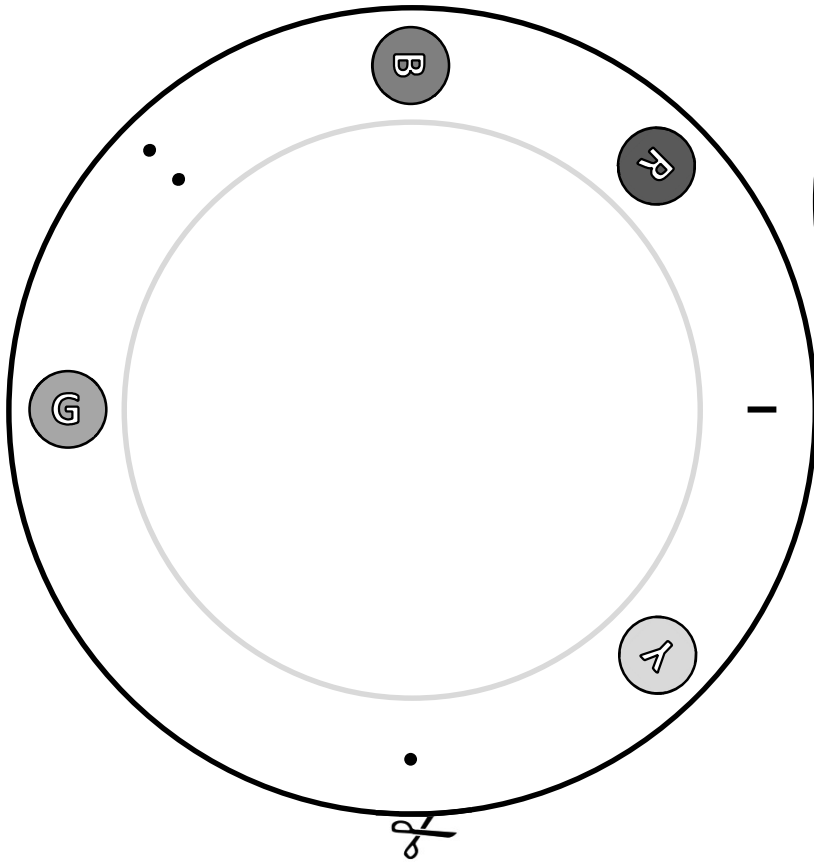

Twister Turn →

Stack circles
here

→ Result

Taboo



In Taboo, the **directions** say you are allowed to give your partner clues that best **encompass** the word you are trying to get them to say, while * you from using certain words.

G
N
I
R
R
A
B

* B

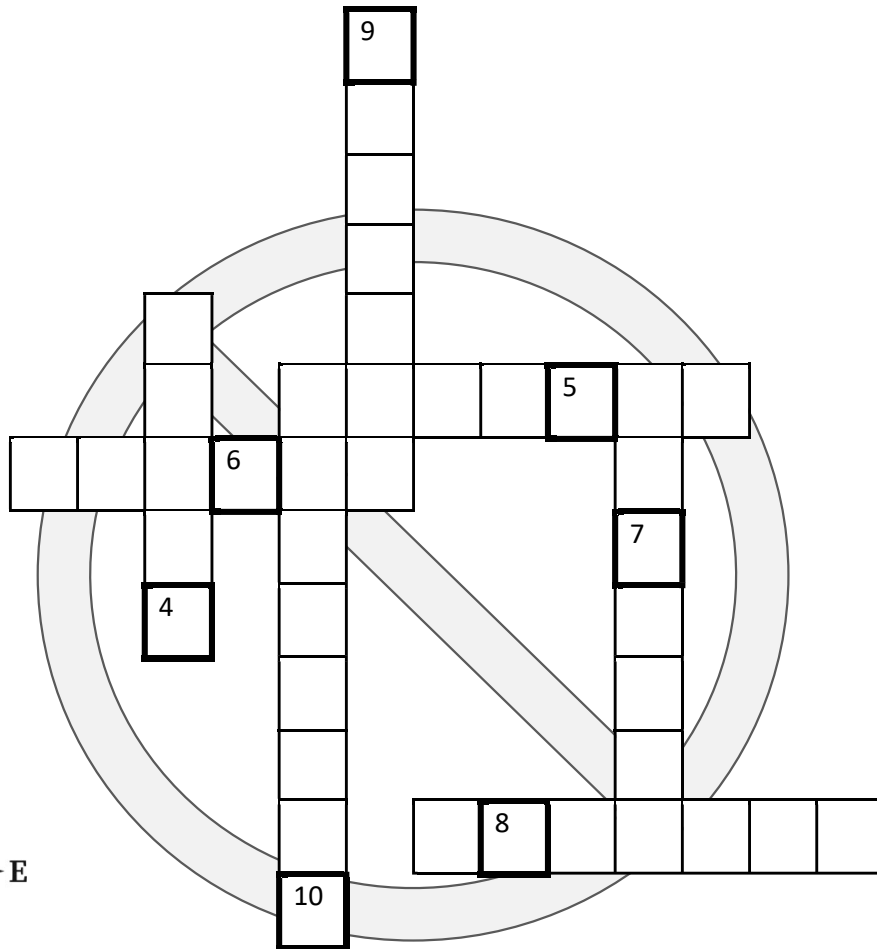
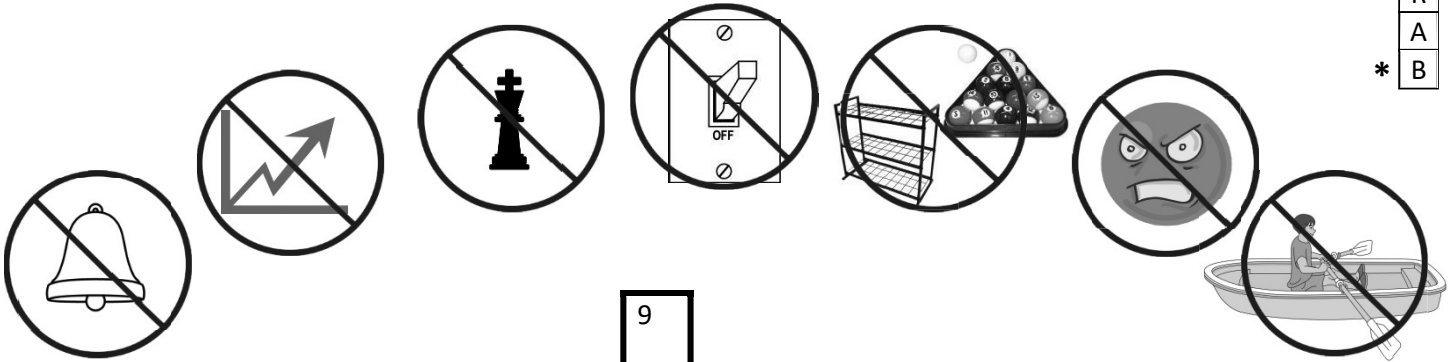

Who likes to break taboos?



Clue



Four suspects each need to pick up their favorite weapon on their way to a room. They go through every empty square on the mansion's floor (and not to any named rooms except their destination). No square is entered more than once. When they pick up a weapon, they don't leave a trace, and they keep moving until they end at their intended destination.

Mrs. Peacock is looking forward to waving her weapon around savagely in the Ballroom.

Prof. Plum wants to disguise his weapon as decoration in the Billiard Room.

Mr. Green would like to use his weapon to pare some fruit in the Hall.

Colonel Mustard is planning to coil his weapon around some pots in the Kitchen.

Note: All moves are orthogonal.

| | | | | | | | |
|-------------------|--------------|---|----------|----------------|--------------|------------|-----------------|
| THE STUDY | Prof. Plum → | | | Mrs. Peacock ↓ | | | THE LOUNGE |
| Miss Scarlet | □ | □ | | | | □ | □ |
| THE LIBRARY | | | | □ | | □ | □ |
| THE BILLIARD ROOM | □ | | | | | | |
| | | | | | | | Col. Mustard ↑ |
| | | | □ | □ | | | THE DINING ROOM |
| | | | | □ | | | |
| THE CONSERVATORY | Mr. Green ↑ | □ | THE HALL | | THE BALLROOM | Mrs. White | THE KITCHEN |

What happened to the suspects at the millionaire's mansion?

They

□



**Puzzled
Pint**
November 2024



Simon



The game Simon is all about remembering how the colors link together and knowing what comes next.

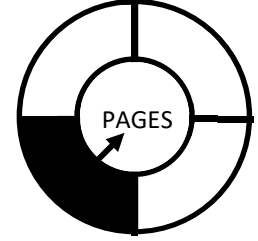
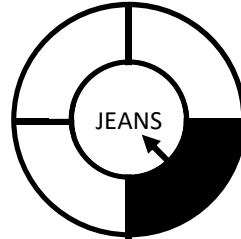
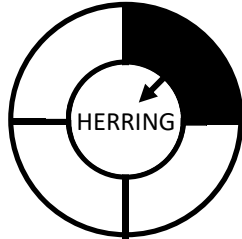
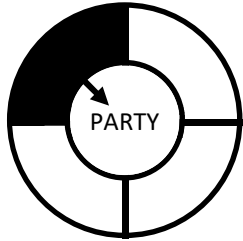

| | | | | | |
|--|---------|-----------|-----------|-----------|-----------------|
| | — | — — | | — | — — — — |
| | — — — — | — | | — | — — — — — — — — |
| | — | — — — — | | — — — — | — — — — — |
| | — — — — | — | | — — — — — | — — — — |
| | — | — — — — | | — — — — — | — |
| | — | — — — — | | — | — — — — — — — — |
| | — — — — | — | | — — — — — | — — — — |
| | — — — — | — | | — — — — | — — — — |
| | — | — — — — — | | — | — — — — |
| | — | — — — — — | — — — — — | — | — |

Someone keeping track of how many podded vegetables are used

Cowardly way of expressing yourself in movement

Where the people who receive soccer warnings have to sit, shuffle, and deal

Professional needed after celebs strut their way into the Oscars with muddy Pradas

Clavicle that does manual or trades-related work

Business loss or debt that you put in your printer

Disruptive brightness in the night sky caused by a 'stop' signal

It keeps matcha snug and warm in the pot

USB device for storing information about becoming a top-notch gardener

Observing the largest animal on the planet