



December 2021 – GILLIGAN'S ISLAND Answer Sheet

Welcome to Puzzled Pint!

Tonight

- We're here to help! This is not a competitive event. Ask the Game Control volunteers (GC) for hints as often as you'd like. The goal is to have fun, not to be frustrated!
- You can find complete information about this puzzle set online at: <http://puzzledpint.com>
 - Go to the location page there to find out if your location is running virtually and how to contact your local GC.
 - Look there for online solving tools for remote teams, like Google sheets and answer checkers.

The Puzzles

- Each puzzle's solution will be a short word or phrase. How do you find it? That's for you to discover!
- Need a **code sheet** or solving resources? Scan this QR code for a link to the Resources page on Puzzled Pint's web site:
<http://www.puzzledpint.com/resources/>
- You can use anything to help solve: Use your phone; the internet is fair game! Think your brother might have an insight? Give him a call!
- While each month has a theme, you need no special knowledge of the theme to solve.



About Puzzled Pint

- We're an all-volunteer organization.
- Help us run locally: Talk with Game Control about how you can volunteer.
- Help us run globally:
<https://www.patreon.com/PuzzledPint>
- How did tonight go? Email us at feedback@puzzledpint.com or scan this QR code for a link to fill out a brief survey.



Team Name: _____

Start Time: _____

Team Size: _____

End Time: _____

| Puzzle Answers | |
|----------------------|--|
| the HOWELLS | |
| Ginger | |
| MARY ANN | |
| PROFESSOR | |
| SKIPPER | |
| Meta: GILLIGAN | |
| BONUS: S.S. MINNOW | |
| BONUS: VISITORS | |
| Meta-Meta: the RADIO | |



Thurston and Lovey Howell are planning a party for December 14, which they always celebrate since it comes only once a year.*

Their invitation and RSVP cards are shown here. What is the location for their party?





Mr. & Mrs. Thurston Howell III



*cordially invite you to their
December 14 celebration.*



*You will need to work together
to reveal the location.*

*Please use the RSVP cards
to indicate your attendance.*





Ginger Grant

will attend

will not attend



Mary Ann Summers

will attend

will not attend



Professor Roy Hinkley

will attend

will not attend

*This was mentioned in passing in episode #2.17. You don't need any knowledge of Gilligan's Island to solve the puzzles in this set.



Gilligan

will attend

will not attend



Skipper Jonas Grumby

will attend

will not attend

Print in color, then cut out the RSVP cards.

Or arrange cards online:
<https://bit.ly/Gilligan-cards>

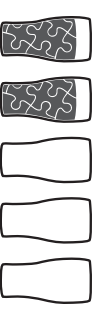

Ginger has been reading through movie scripts from a crate that washed up onto the island. She discovers that the script pages have gotten intermingled, resulting in combinations that form new stories. Figure out the titles for the plots described below. The highlighted letters will reveal what Ginger is bringing to the December 14 celebration.

Farm boy Westley rescues Buttercup from Prince Humperdinck, only to find she's married to a scientist creating a monster.

----- -----

A renowned playwright's romance with the actress playing his script's Romeo is one of several relationships explored during the Christmas season in Britain.

----- -----

Investors bet against the mortgage market while saving Number 5, an intelligent robot who doesn't want to be disassembled.

----- -----

In this sequel, Daniel adds to his original eleven to time-travel into the past to find the cause of a devastating pandemic.

----- , -----

A military lawyer disproves the accusation that he "can't handle the truth" and joins an elite, well-dressed group protecting Earth from aliens.

----- -----

Loosely based on Prince's early career, this movie tells the story of Charlie Babbit reuniting with his autistic savant brother.

----- -----

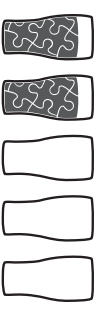
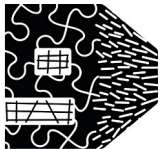

After being released from a mental hospital, Karl Childers hunts down and “retires” replicants.

----- -----

The presidential jet is hijacked by the ruthless Nurse Ratched.

----- ----- , -----

Ted goes on a do-over date with his dream girl from high school, who is now a charming nanny, perfect in every way.

----- , ----- -----

A group of reluctant heroes, including a talking raccoon, travels to a distant world to help the Thermians defeat General Sarris.

----- -----

A young mouse has a run-in with the family cat, Snowbell, after being adopted by March sisters Jo, Meg, Amy, and Beth.

----- -----

James Bond seduces Solitaire and foils a hostage situation at the Nakatomi Plaza during a Christmas party.

----- -----

Frank Miller’s noir comics tell of a group of friends who vacation at a dude ranch for a cattle drive that goes wrong.

----- -----



With her Kansas family farm experience, Mary Ann manages the castaways' agriculture and runs a tightly-organized garden. Each crop is in its own area of just the right size, and a carefully-planned path allows access throughout.

Shade squares to represent the path, leaving groups of unshaded squares for the crops.

- Every crop area will have exactly one number in it.
- Every crop area will have exactly one scarecrow. (Some scarecrows will be on the path.)
- Each number specifies how many squares – including itself – are in a crop's area (unshaded squares). Squares are considered part of the area if they touch along edges.
- No crop area may touch any other crop area along an edge. Touching at corners is permitted.
- The entire path (shaded squares) must be connected together along edges.

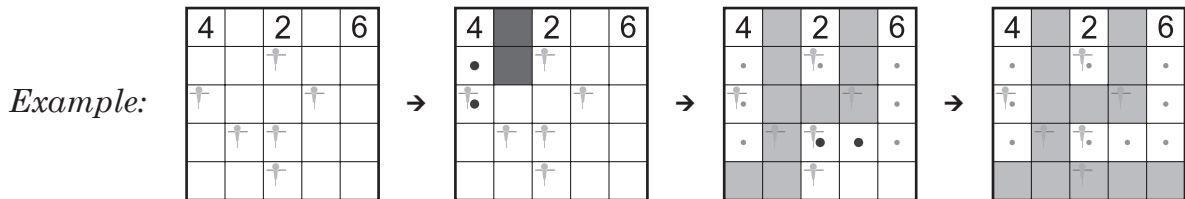

Once you have determined the layout, the scarecrows in the crop areas will help you discover what Mary Ann is bringing to the December 14 celebration.

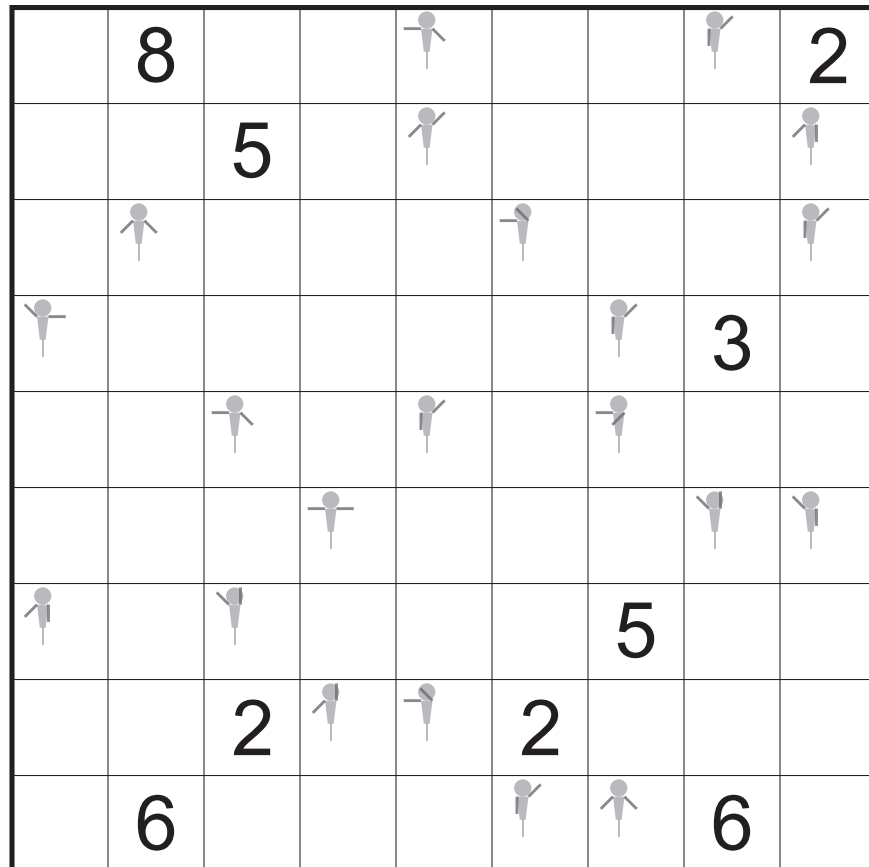

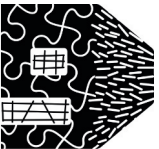

**Puzzled
Pint**
December 2021

PROFESSOR



The Professor is creating a generator and a radio, starting with coconuts (as usual!). He's adding a variety of materials easily found on the island, using laboratory equipment, and employing various techniques in the manufacturing process. The materials, equipment, and techniques are clued below in alphabetical order. Use those clued words to fill in the chains representing the Professor's constructions.

C O C O N U T

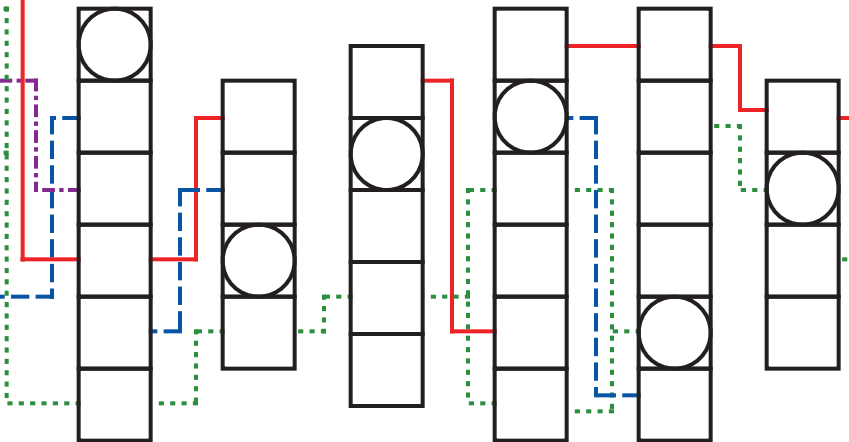

When you're done, you'll find what the Professor is bringing to the December 14 celebration.

common island material

common island fruit

mix

vaporize a liquid using heat

join together

shallow container with
a rounded bottom

tool used to chip away

cut

split apart

bore

adhere

deform beyond recognition

another common island material

yet another common island material

C O C O N U T

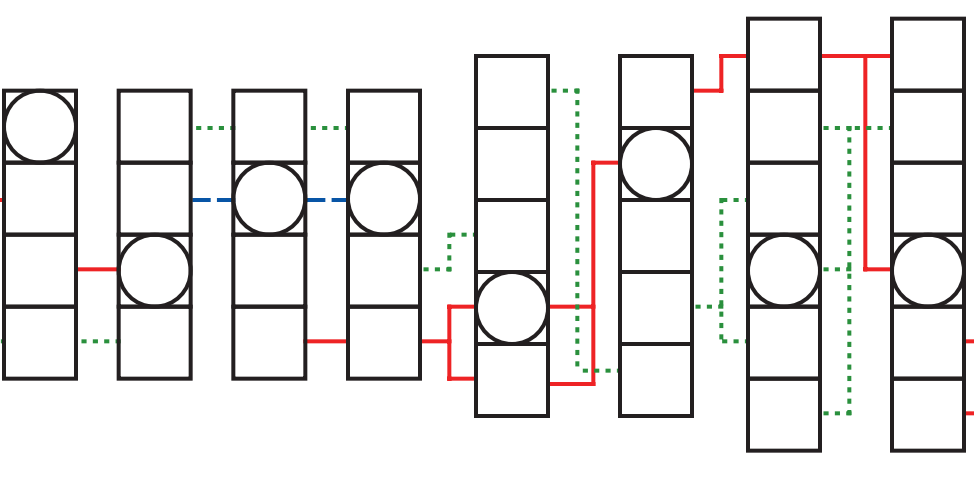

R A D I O



The Skipper is a bit paranoid about encountering hostile natives. Thus, when there are unexplained happenings, he often jumps to the conclusion that head hunters are responsible.

Help the Skipper find the missing “heads” for the sets below. In addition to losing their heads, each set has also lost a word. Fortunately, they are not missing, just misplaced.

The misplaced words – when reunited with their sets – will help you select one letter from each of the “head” words to discover what the Skipper is bringing to the December 14 celebration.

| Heads | Sets |
|-------|-----------------------|
| _____ | eel, vehicle, _____ |
| _____ | mail, reaction, _____ |
| _____ | bear, hole, _____ |
| _____ | chair, way, _____ |
| _____ | storm, White, _____ |
| _____ | buffalo, wheel, _____ |
| _____ | clip, cut, _____ |
| _____ | tack, wrestle, _____ |
| _____ | arrest, plant, _____ |
| _____ | bath, tea, _____ |

Misplaced words:

| | | | | |
|--------------|-----------|------------|---------|----------|
| airplane (2) | flake (1) | guitar (5) | gum (6) | key (3) |
| link (4) | melon (3) | print (1) | Sea (5) | tide (2) |



As usual, Gilligan's actions are having an impact on what the others are doing. This has resulted in changing what they intended to bring to the December 14 celebration.

Use the instructions below to transform answers from the other puzzles to form new words. For puzzle answers that are multiple words, use each word separately. Every word will be used exactly once.

As you transform each word, you'll find a part of what Gilligan contributed to the celebration.

Puzzle answers:

the HOWELS _____
GINGER _____
MARY ANN _____
PROFESSOR _____
SKIPPER _____

Transformations:

Change the first letter to get counterfeit. _____ → _____

Remove a board game, then change a vowel to get a mammal. _____ → _____

Delete the first half of the word, then replace a letter to get liquor. _____ → _____

Remove both copies of a duplicated vowel and the letter between that pair, then change the second letter to get a root vegetable. _____ → _____

Change the first letter to get an informational site with collaborative editing. _____ → _____

Replace a pronoun with one letter to get part of a room. _____ → _____

Replace two consecutive double-letter pairs (four letters) with a single letter to get farm structures. _____ → _____

Change the middle letter, then drop the last letter to get a body of water. _____ → _____

Change the last letter to get the condition of a person or thing. _____ → _____



Visitors



For being uncharted, Gilligan’s Island sure had a lot of visitors, yet none of them told the outside world about the castaways’ plight and location. Perhaps there was more than just bad luck keeping them lost. Match up the visitors with the reasons they didn’t (or couldn’t) bring rescuers to the island, and you will see what kept those poor people stranded for three seasons. *(This puzzle is based on actual plots from the episodes, not on wordplay. Most connections can be inferred from the descriptions.)*

- | | | | |
|----------------------------|---|---|---|
| Big Game Hunter • | C | T | • Unable to give useful directions |
| Broadway Producer • | H | O | • Wanted to steal Ginger’s career |
| Cosmonauts • | S | A | • Hit head on rock returning on “reverse tsunami” |
| Eva Grubb • | R | G | • Stole idea for “Hamlet the Musical” |
| Jungle Boy • | C | R | • Got turned into a cat by his own machine |
| Mad Scientist • | E | N | • Covered up rules violation |
| Robot • | L | L | • Feared punishment for trying to kill Gilligan |
| Surfer • | S | I | • Had poor language skills |
| “Take a Dare” Contestant • | I | M | • Feared competition with a girl band |
| The Mosquitoes • | A | R | • Embarrassed their splashdown was off target |
| Wrongway Feldman • | G | A | • Message demagnetized by Gilligan’s rabbit foot |



**Puzzled
Pint**
December 2021
MET A
MET A

The Radio

2021 year in review

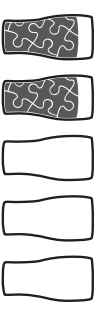

For your convenience, here are all the metapuzzle answers of 2021.

We interrupt this event to bring you a special news bulletin from the Pacific. Recent puzzles have led to a renewed interest in the S.S. Minnow, a small sightseeing boat that sailed many years ago from Honolulu Harbor on a three hour tour. A three hour tour.

The ship's complement of seven passengers and crew have not been seen or heard from in many years. Twelve ships have been dispatched to a group of uncharted islands, in hopes that these seven persons might be found:

- Mustard I Gems I
- Olympus III Warrior VI
- Detective V Timey-wimey III
- Pyramid XXIV Website VII
- Kings and Queens V Baudelaire IV
- Stranded VI
- Last Year III

We encourage all listeners to report any information they may have regarding how we might ever see them again.

©2021 CC BY-NC-SA 4.0
Joey Maricner (Seattle, WA, USA)



December 2021
Gulligan's Island



Nov 2021
Seven Wonders of the Ancient World



October 2021
Condiments



September 2021
Tenet



August 2021
Vikings



July 2021
Agatha Christie's Poirot



June 2021
Chess



May 2021
Steven Universe



April 2021
Greek Mythology



March 2021
Life in 2020



Feb 2021
A Series of Unfortunate Events



January 2021
Puzzlefeed